









Ford kopče

	Ford univerzalne kopče						
	boja	glavaØ (mm)	tiplaØ (mm)	ukupna dužina (mm)	pakovanje /kom	fabrički broj	GRT Nr.
	crna	15,7	8	12,5	25	-	182 003
	Ford Fiesta kopče za tapacir						
	boja	glavaØ (mm)	tiplaØ (mm)	ukupna dužina (mm)	pakovanje /kom	fabrički broj	GRT Nr.
	crna	13,7	7	13,4	25	-	183 000
	Ford Escort, Fiesta kopče za tapacir						
	boja	glavaØ (mm)	tiplaØ (mm)	ukupna dužina (mm)	pakovanje /kom	fabrički broj	GRT Nr.
	crna	18	8	18,4	25	-	183 001
	Ford Escort, Fiesta kopče za tapacir						
	boja	glavaØ (mm)	tiplaØ (mm)	ukupna dužina (mm)	pakovanje /kom	fabrički broj	GRT Nr.
	siva	18	8	18,4	25	1443038	183 002
	Ford Escort, Fiesta kopče za tapacir						
	boja	glavaØ (mm)	tiplaØ (mm)	ukupna dužina (mm)	pakovanje /kom	fabrički broj	GRT Nr.
	crna	25,3	8	14	25	6448410	183 003
	Ford univerzalne kopče za tapacir						
	boja	glavaØ (mm)	tiplaØ (mm)	ukupna dužina (mm)	pakovanje /kom	fabrički broj	GRT Nr.
	crna	30	7	17,6	25	-	183 004
	Ford univerzalne kopče za tapacir						
	boja	glavaØ (mm)	tiplaØ (mm)	ukupna dužina (mm)	pakovanje /kom	fabrički broj	GRT Nr.
	crna	35	22-30	18,3	25	-	183 005
	Ford Fiesta kopče za tapacir						
	boja	glavaØ (mm)	tiplaØ (mm)	ukupna dužina (mm)	pakovanje /kom	fabrički broj	GRT Nr.
	crna	16	6,5	19,6	25	-	183 006

Ford kopče

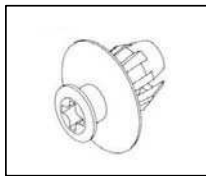

Ford Escort, Fiesta kopče za tapacir

boja	glavaØ (mm)	tiplaØ (mm)	ukupna dužina (mm)	pakovanje /kom	fabrički broj	GRT Nr.
crna	25	11	16,7	25	-	183 007

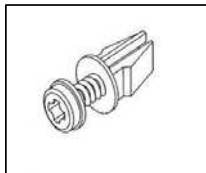

Ford Fiesta kopče za tapacir

boja	glavaØ (mm)	tipla (mm)	ukupna dužina (mm)	pakovanje /kom	fabrički broj	GRT Nr.
crna	12,2	8x9,6	17	25	-	183 008

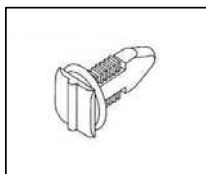

Ford Fiesta kopče za tapacir

boja	glava (mm)	tipla (mm)	ukupna dužina (mm)	pakovanje /kom	fabrički broj	GRT Nr.
crna	11,6x11,6	4,3x7	25,3	25	-	183 009

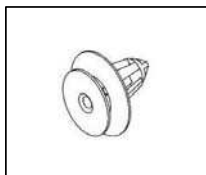

Ford univerzalne kopče za tapacir sa vrata

boja	glavaØ (mm)	tiplaØ (mm)	ukupna dužina (mm)	pakovanje /kom	fabrički broj	GRT Nr.
bež	13,2	8	17,8	25	-	183 010

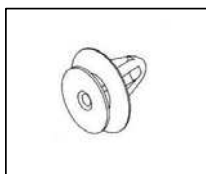

Ford Escort, Fiesta kopče za tapacir sa vrata

boja	glavaØ (mm)	tiplaØ (mm)	ukupna dužina (mm)	pakovanje /kom	fabrički broj	GRT Nr.
crna	13,2	8		25	6117693	183 011



Ford Fiesta kopče za tapacir sa vrata

boja	glavaØ (mm)	tiplaØ (mm)	ukupna dužina (mm)	pakovanje /kom	fabrički broj	GRT Nr.
siva	13,3	9	19	25	6117693	183 012

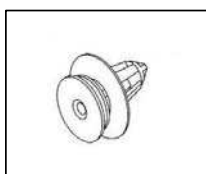

Ford Fiesta kopče za tapacir sa vrata



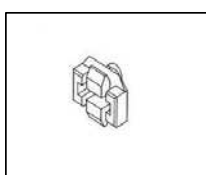





boja	glavaØ (mm)	tiplaØ (mm)	ukupna dužina (mm)	pakovanje /kom	fabrički broj	GRT Nr.
plava	13	8	20	25	6099812	183 013

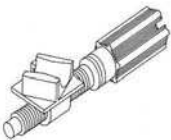

Ford Fiesta kopče za lajsne vetrobrana

boja	glava (mm)	tipla (mm)	visina (mm)	pakovanje /kom	fabrički broj	GRT Nr.
bela	8x10	4x9,3	5	10	-	183 014

Ford kopče

	Ford Fiesta kopče za lajsne vetrobrana						
	boja	glava (mm)	tipla (mm)	visina (mm)	pakovanje db/csomag	fabrički broj	GRT Nr.
	fekete	8x10	4x9,3	7,7	25	6053937	183 015
	Ford univerzalna kopča za šraf od 4,8 mm						
	boja	glava (mm)	tipla (mm)	ukupna dužina (mm)	pakovanje /kom	fabrički broj	GRT Nr.
	Crna	13,3x15,5	10x13,2	14	25	-	183 016
	Ford Fiesta kopča za fiksiranje fara, desna						
	mera (mm)				pakovanje /kom	fabrički broj	GRT Nr.
	M8x83				5	-	183 018
	Ford Fiesta kopča za fiksiranje fara, leva						
	mera (mm)				pakovanje /kom	fabrički broj	GRT Nr.
	M8x83				5	-	183 019
	Ford Sierra klizači branika						
	mera (mm)				pakovanje /kom	fabrički broj	GRT Nr.
	36x48				5	-	183 020
	Ford Fiesta klizači branika						
	mera (mm)				pakovanje /kom	fabrički broj	GRT Nr.
	40x50				5	6123256	183 021
	Ford univerzalne kopče za fiksiranje kablova						
	boja	mera (mm)	tiplaØ (mm)	visina (mm)	pakovanje /kom	fabrički broj	GRT Nr.
	crna	13x18	6,2	28,5	10	6105034	183 023
	Ford Focus kopče za tapacir sa vrata						
	boja	glavaØ (mm)	tiplaØ (mm)	ukupna dužina (mm)	pakovanje /kom	fabrički broj	GRT Nr.
	bela	13	8	25,4	25	1070107	183 024

Ford kopče



Ford Fiesta, KA kopče za tapacir sa vrata

boja	glavaØ (mm)	tiplaØ (mm)	ukupna dužina (mm)	pakovanje /kom	fabrički broj	GRT Nr.
bela	12,7	8	20,8	25	6176723	183 027

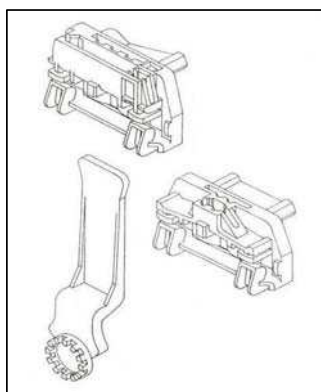

Ford Focus 1998-2005 set za reparaturu podizača stakla, leva

pakovanje /kom	fabrički broj	GRT Nr.
3	-	183 028

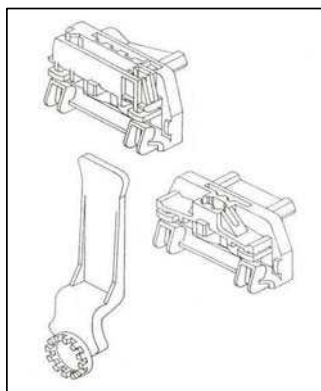

Ford Focus 1998-2005 set za reparaturu podizača, desna

pakovanje /kom	fabrički broj	GRT Nr.
3	-	183 029

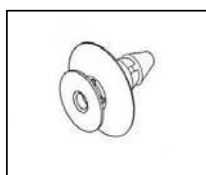

Ford KA kopče za ukrasne rubove

boja	glavaØ (mm)	tiplaØ (mm)	ukupna dužina (mm)	pakovanje /kom	fabrički broj	GRT Nr.
bela	13	8	18,3	25	1038008	183 030



Ford KA tiple za kopče od ukrasne lajsne za rubove

boja	glavaØ (mm)	tiplaØ (mm)	ukupna dužina (mm)	pakovanje /kom	fabrički broj	GRT Nr.
bela	13,8	8	9,5	25	1031769	183 031

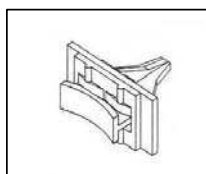

Ford Transit kopče za tapacir

boja	glava (mm)	tipla (mm)	ukupna dužina (mm)	pakovanje /kom	fabrički broj	GRT Nr.
crna	6x17,2	6,2x10,6	25,2	10	4069906	183 032

Ford kopče

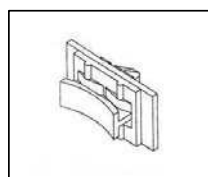

Ford Transit kopče za tapacir

boja	glava (mm)	tipla (mm)	ukupna dužina (mm)	pakovanje /kom	fabrički broj	GRT Nr.
bela	6x17,2	6,2x10,6	16	10	4069907	183 033



Ford kopče za tapacir

boja	glavaØ (mm)	tiplaØ (mm)	ukupna dužina (mm)	pakovanje /kom	fabrički broj	GRT Nr.
crna	17,8	6,5	20,7	25	N808147S	183 034

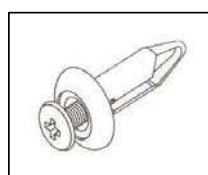

Ford kopče za tapacir

boja	glavaØ (mm)	tiplaØ (mm)	ukupna dužina (mm)	pakovanje /kom	fabrički broj	GRT Nr.
crna	15,3	6,5	26	25	N803946S	183 035



Ford kopče za plastične obloge

boja	glavaØ (mm)	tiplaØ (mm)	ukupna dužina (mm)	pakovanje /kom	fabrički broj	GRT Nr.
crna	20	8	24,6	25	N807389S	183 036

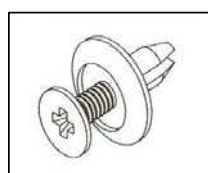

Ford kopče za tapacir

boja	glavaØ (mm)	tiplaØ (mm)	ukupna dužina (mm)	pakovanje /kom	fabrički broj	GRT Nr.
crna	17,2	6,5	15,5	25	N806322-S	183 037



Ford kopče za izolaciju haube

boja	glavaØ (mm)	tiplaØ (mm)	ukupna dužina (mm)	pakovanje /kom	fabrički broj	GRT Nr.
crna	30	7	22	10	386553-S	183 038



Ford kopče za izolaciju haube

boja	glavaØ (mm)	tiplaØ (mm)	ukupna dužina (mm)	pakovanje /kom	fabrički broj	GRT Nr.
crna	45	7	21	10	388908-S	183 039



Ford kopče za tapacir sa vrata

boja	glava (mm)	tiplaØ (mm)	ukupna dužina (mm)	pakovanje /kom	fabrički broj	GRT Nr.
bez.b.	16x23,5	7	30	10	387496-S	183 040

Ford kopče

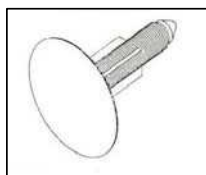

Ford Transit kopče za nebo

boja	glavaØ (mm)	tiplaØ (mm)	ukupna dužina (mm)	pakovanje /kom	fabrički broj	GRT Nr.
siva	30	7/10,2	52	10	4440369	183 041



Ford kopče za tapacir

boja	glavaØ (mm)	tiplaØ (mm)	ukupna dužina (mm)	pakovanje /kom	fabrički broj	GRT Nr.
siva	25,5	7	46,8	25	-	183 042



Ford Transit kopče za nebo

boja	glavaØ (mm)	tiplaØ (mm)	ukupna dužina (mm)	pakovanje /kom	fabrički broj	GRT Nr.
siva	26	7		10	4128550	183 043



Ford Fiesta, KA, Mondeo tipla za podkrlia

boja	glavaØ (mm)	tipla (mm)	ukupna dužina (mm)	pakovanje /kom	fabrički broj	GRT Nr.
zelena	20	8,3x10	12,5	25	6150260	183 044



Ford kopče za tapacir

boja	glavaØ (mm)	tiplaØ (mm)	ukupna dužina (mm)	pakovanje /kom	fabrički broj	GRT Nr.
crna	12,5	7	35	25	N805026S	185 555



Ford kopče za tapacir

boja	glavaØ (mm)	tiplaØ (mm)	ukupna dužina (mm)	pakovanje /kom	fabrički broj	GRT Nr.
crna	14	7	15	25	387258-S	185 558



Ford kopče za tapacir

boja	glavaØ (mm)	tiplaØ (mm)	ukupna dužina (mm)	pakovanje /kom	fabrički broj	GRT Nr.
crna	18	7	22,4	25	388577S	185 564



Ford kopče za tapacir

boja	glavaØ (mm)	tiplaØ (mm)	ukupna dužina (mm)	pakovanje /kom	fabrički broj	GRT Nr.
siva	18	7	22,4	25	-	185 565

Ford kopče

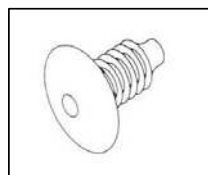

Ford kopče za tapacir						
boja	glavaØ (mm)	tiplaØ (mm)	ukupna dužina (mm)	pakovanje /kom	fabrički broj	GRT Nr.
crna	20,3	8	22,6	25	-	186 004

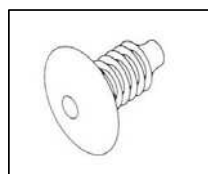

Ford kopče za tapacir						
boja	glavaØ (mm)	tiplaØ (mm)	ukupna dužina (mm)	pakovanje /kom	fabrički broj	GRT Nr.
siva	20,3	8	22,6	25	-	186 005

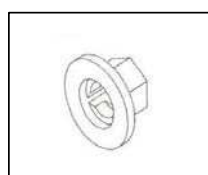

Ford navrtka obloge						
boja	glavaØ (mm)	šraf	visina (mm)	pakovanje /kom	fabrički broj	GRT Nr.
crna	16,3	M6	10	25	-	186 025

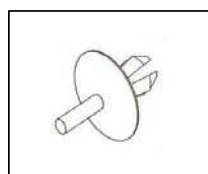

Ford kopče za fiksiranje branika						
boja	glavaØ (mm)	tiplaØ (mm)	ukupna dužina (mm)	pakovanje /kom	fabrički broj	GRT Nr.
crna	16	5,5	13,2	25	-	186 032

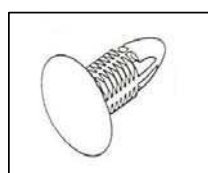

Ford Escort, Orion kopče za tapacir						
boja	glavaØ (mm)	tiplaØ (mm)	ukupna dužina (mm)	pakovanje /kom	fabrički broj	GRT Nr.
crna	18	7	23,2	25	1618747	187 563



Ford kopče za fiksiranje branika						
boja	glava (mm)	tiplaØ (mm)	ukupna dužina (mm)	pakovanje /kom	fabrički broj	GRT Nr.
siva	20x30	10	14	10	E7GZ-17A904-B	187 711



Ford kopče za fiksiranje branika						
boja	glava (mm)	tiplaØ (mm)	ukupna dužina (mm)	pakovanje /kom	fabrički broj	GRT Nr.
crna	20,3x30,3	10	23,5	10	E92Z-17C7756C	187 712

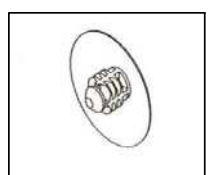

Ford kopče za izolaciju haube						
boja	glavaØ (mm)	tiplaØ (mm)	ukupna dužina (mm)	pakovanje /kom	fabrički broj	GRT Nr.
crna	19,4	6	9,2	25	F22Z-16774-A	187 713

Ford kopče



Ford univerzalne kopče za tapacir sa vrata

boja	glavaØ (mm)	tiplaØ (mm)	ukupna dužina (mm)	pakovanje /kom	fabrički broj	GRT Nr.
crna	13,7	8	21,2	25	-	188 011

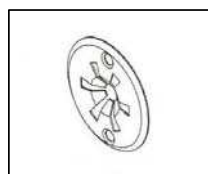

Ford univerzalne kopče

boja	glavaØ (mm)	tiplaØ (mm)	debljina (mm)	pakovanje /kom	fabrički broj	GRT Nr.
srebrna	30	4	2,2	10	6715468	188 060

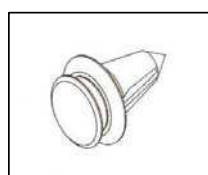

Ford Galaxy kopče za tapacir sa vrata

boja	glavaØ (mm)	tiplaØ (mm)	ukupna dužina (mm)	pakovanje /kom	fabrički broj	GRT Nr.
žuta	13,2	8	21	25	1008068	188 083



Ford Galaxy kopče za keder gumu

boja	glava (mm)	tiplaØ (mm)	ukupna dužina (mm)	pakovanje /kom	fabrički broj	GRT Nr.
crna	6x15	5	18,5	25	-	188 140



Ford univerzalni šraf za lim

boja	glavaØ (mm)	navoj (mm)	ukupna dužina (mm)	pakovanje /kom	fabrički broj	GRT Nr.
žuta	15	5,5	19	100	-	190 176



Ford univerzalni šraf za lim

boja	glavaØ (mm)	navoj (mm)	ukupna dužina (mm)	pakovanje /kom	fabrički broj	GRT Nr.
žuta	18	6,3	19	100	-	190 177

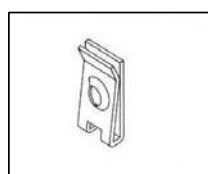

Ford univerzalna limena matica

šraf (mm)	mera (mm)	za lim (mm)	sred.rupa (mm)	pakovanje /kom	fabrički broj	GRT Nr.
6,3	24,8x16	0,7-1,5	10,5	50	-	191 207

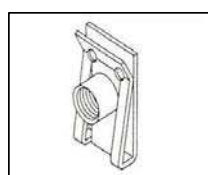

Ford univerzalna limena matica sa metričkim navojem

šraf	mera (mm)	za lim (mm)	sred.rupa (mm)	pakovanje /kom	fabrički broj	GRT Nr.
M5	21,7x14,5	0,9-4,8	11,5	25	-	191 225

Ford kopče

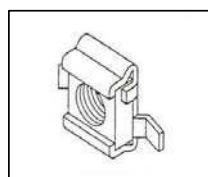

Ford univerzalne četvrtaste navrtke

šraf	mera (mm)	za lim (mm)	visina (mm)	pakovanje /kom	fabrički broj	GRT Nr.
M4	12,0-12,7	0,7-1,7	5,6	25	-	191 275

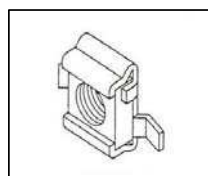

Ford univerzalne četvrtaste navrtke

šraf	mera (mm)	za lim (mm)	visina (mm)	pakovanje /kom	fabrički broj	GRT Nr.
M6	11,5x12,6	0,7-1,7	6,3	25	4327419	191 276

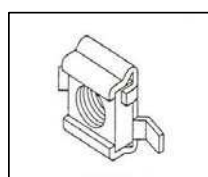

Ford univerzalne četvrtaste navrtke

šraf	mera (mm)	za lim (mm)	visina (mm)	pakovanje /kom	fabrički broj	GRT Nr.
M8	16,0x19,1	0,7-2	7,4	25	14649290	191 277

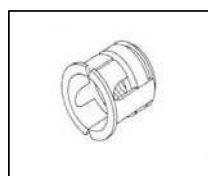

Ford univerzalne navrtke

šraf	meraØ (mm)	za lim (mm)	visina (mm)	pakovanje /kom	fabrički broj	GRT Nr.
M4	10	0,7-4	13	25	-	191 299

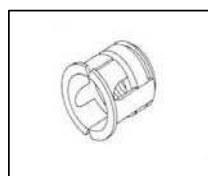

Ford univerzalne navrtke

šraf	meraØ (mm)	za lim (mm)	visina (mm)	pakovanje /kom	fabrički broj	GRT Nr.
M5	10	0,7-4	13	25	-	191 300

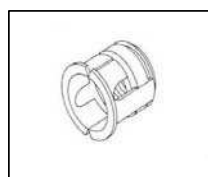

Ford univerzalne navrtke

šraf	meraØ (mm)	za lim (mm)	visina (mm)	pakovanje /kom	fabrički broj	GRT Nr.
M6	10	0,7-4	13	25	-	191 301

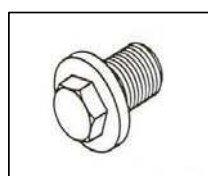

Ford šraf za karter

boja	glavaØ (mm)	navoj	ukupna dužina (mm)	pakovanje /kom	fabrički broj	GRT Nr.
srebrna	23	M14x1,5	26	5	-	191 342