

Citroen, Peugeot kopče

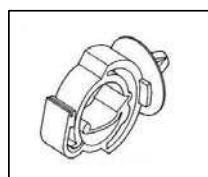

Citroen pvc lisice za fiksiranje kablova

boja	mera (mm)	tipla Ø (mm)	visina (mm)	pakovanje /kom	fabrički broj	GRT Nr.
crna	6-12	6,2	30	25	-	145 136

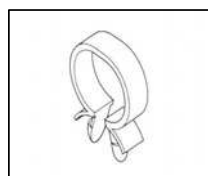

Peugeot univerzalne kopče za fiksiranje kablova

boja	mera (mm)	tipla Ø (mm)	visina (mm)	pakovanje /kom	fabrički broj	GRT Nr.
crna	6,0-7,8	6,5	14,6	25	-	166 100

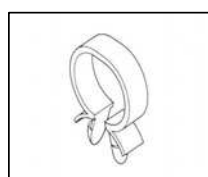

Peugeot univerzalne kopče za fiksiranje kablova

boja	mera (mm)	tipla Ø (mm)	visina (mm)	pakovanje /kom	fabrički broj	GRT Nr.
crna	8,2-10,8	6,5	19,4	25	-	166 101

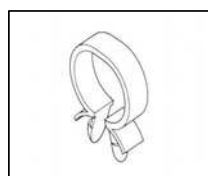

Peugeot univerzalne kopče za fiksiranje kablova

boja	mera (mm)	tipla Ø (mm)	visina (mm)	pakovanje /kom	fabrički broj	GRT Nr.
crna	13,5-16,8	6,5	25,2	25	-	166 102

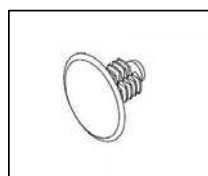

Citroen kopče za tapacir

boja	glavaØ (mm)	tiplaØ (mm)	ukupna dužina (mm)	pakovanje /kom	fabrički broj	GRT Nr.
crna	18,5	6,5	14	25	-	180 014

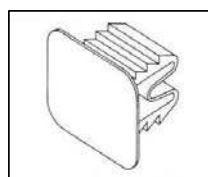

Citroen C25, Jumper, Peugeot Boxer I, J5 kopče za izolaciju haube

boja	glava (mm)	tipla (mm)	ukupna dužina (mm)	pakovanje /kom	fabrički broj	GRT Nr.
crna	20,2x25,3	10x13,3	14	25	797954	180 025

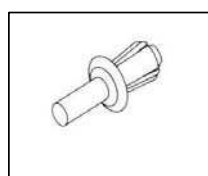

Citroen kopče za tapacir



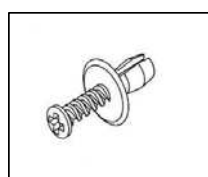





boja	glavaØ (mm)	tiplaØ (mm)	ukupna dužina (mm)	pakovanje /kom	fabrički broj	GRT Nr.
crna	11	6,2	12,3	25	-	180 027





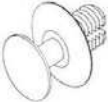





Citroen, Peugeot kopče za tapacir

boja	glavaØ (mm)	tiplaØ (mm)	ukupna dužina (mm)	pakovanje /kom	fabrički broj	GRT Nr.
crna	12,5	6,2	13,7	25	-	180 032





Citroen, Peugeot kopče

	Peugeot kopče za tapacir sa vrata						
	boja	glava (mm)	tiplaØ (mm)	ukupna dužina (mm)	pakovanje /kom	fabrički broj	GRT Nr.
	crna	6,7x13,2	9	18,3	25	-	180 037
	Peugeot kopče za tapacir sa vrata						
	boja	glavaØ (mm)	tiplaØ (mm)	ukupna dužina (mm)	pakovanje /kom	fabrički broj	GRT Nr.
	bela	13,4	8,5	17	25	-	180 038
	Citroen, Peugeot univerzalne kopče za šraf od 4,2 mm						
	boja	glavaØ (mm)	tipla (mm)	ukupna dužina (mm)	pakovanje /kom	fabrički broj	GRT Nr.
	bela	13	6,2x7,5	9,2	25	-	180 056
	Citroen, Peugeot univerzalni gumeni odbojnici						
	boja	mera (mm)			pakovanje /kom	fabrički broj	GRT Nr.
	crna	17x44,5			10	-	180 084
	Peugeot kopče za tapacir						
	boja	glavaØ (mm)	tiplaØ (mm)	ukupna dužina (mm)	pakovanje /kom	fabrički broj	GRT Nr.
	crna	20	8	16,4	25	-	181 006
	Citroen, Peugeot kopče za tapacir						
	boja	glavaØ (mm)	tiplaØ (mm)	ukupna dužina (mm)	pakovanje /kom	fabrički broj	GRT Nr.
	crna	18,4	6,5	14	25	6992C6	182 000
	Citroen, Peugeot kopče za tapacir						
	boja	glavaØ (mm)	tiplaØ (mm)	ukupna dužina (mm)	pakovanje /kom	fabrički broj	GRT Nr.
	crna	8	3,5	10,4	25	697207	182 001
	Peugeot kopče za tapacir						
	boja	glavaØ (mm)	tiplaØ (mm)	ukupna dužina (mm)	pakovanje /kom	fabrički broj	GRT Nr.
	crna	11,3	4,8	11,4	25	-	182 002

Citroen, Peugeot kopče

	Citroen kopče za podkrila						
	boja	glavaØ (mm)	tiplaØ (mm)	ukupna dužina (mm)	pakovanje /kom	fabrički broj	GRT Nr.
	crna	15,7	8	12,5	25	-	182 003
	Citroen, Peugeot kopče za tapacir						
	boja	glavaØ (mm)	tiplaØ (mm)	ukupna dužina (mm)	pakovanje /kom	fabrički broj	GRT Nr.
	crna	16,2	8,6	16,2	25	-	182 004
	Citroen kopče za tapacir						
	boja	glavaØ (mm)	tiplaØ (mm)	ukupna dužina (mm)	pakovanje /kom	fabrički broj	GRT Nr.
	crna	12,2	6,2	10,5	25	6555LE	182 005
	Citroen, Peugeot kopče za tapacir sa vrata						
	boja	glavaØ (mm)	tiplaØ (mm)	ukupna dužina (mm)	pakovanje /kom	fabrički broj	GRT Nr.
	bela	13,2	8	16,6	25	699143	182 006
	Citroen, Peugeot kopče za tapacir sa vrata						
	boja	glavaØ (mm)	tiplaØ (mm)	ukupna dužina (mm)	pakovanje /kom	fabrički broj	GRT Nr.
	bela	13,5	6,7	21	25	6999CR	182 007
	Citroen, Peugeot tipla za kopče						
	boja	glavaØ (mm)	tiplaØ (mm)	visina (mm)	pakovanje /kom	fabrički broj	GRT Nr.
	crna	10,8	8	5,8	25	-	182 008
	Peugeot kopče za tapacir sa vrata						
	boja	glava (mm)	tiplaØ (mm)	ukupna dužina (mm)	pakovanje /kom	fabrički broj	GRT Nr.
	crna	6,3x10,8	5,3	12,4	25	699293	182 009
	Peugeot 206, 806 kopče za ukrasne lajsne						
	boja	glava (mm)	tiplaØ (mm)	ukupna dužina (mm)	pakovanje /kom	fabrički broj	GRT Nr.
	bela	8x10	8	15,8	25	856540	182 010

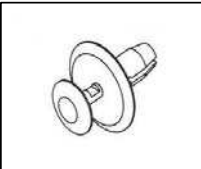
Citroen, Peugeot kopče

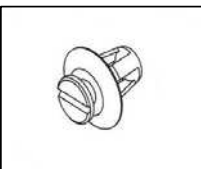
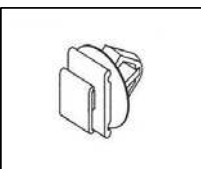
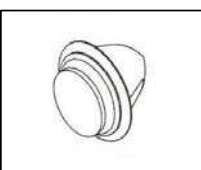
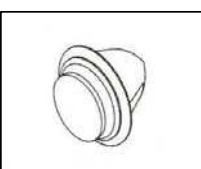
	Citroen, Peugeot kopče za tapacir						
	boja	glavaØ (mm)	tiplaØ (mm)	ukupna dužina (mm)	pakovanje /kom	fabrički broj	GRT Nr.
	bela	10	7	20	25	699645	182 011
	Peugeot 306 kopče za ukrasne lajsne						
	boja	glava (mm)	tiplaØ (mm)	ukupna dužina (mm)	pakovanje /kom	fabrički broj	GRT Nr.
	bela	8x10	6,2	17	25	856520	182 012
	Peugeot 206, 306 kopče za tapacir						
	boja	glavaØ (mm)	tiplaØ (mm)	ukupna dužina (mm)	pakovanje /kom	fabrički broj	GRT Nr.
	crna	22	6,6	15,4	10	699783	182 013
	Citroen Berlingo, Saxo kopče za tapacir sa vrata						
	boja	glavaØ (mm)	tiplaØ (mm)	ukupna dužina (mm)	pakovanje /kom	fabrički broj	GRT Nr.
	bela	11,4	8	21,3	25	699050	182 014
	Citroen Berlingo, Xsara, Peugeot 206 kopče za ukrasne lajsne						
	boja	glavaØ (mm)	tiplaØ (mm)	ukupna dužina (mm)	pakovanje /kom	fabrički broj	GRT Nr.
	crna	10,3	9	20	25	856535	182 015
	Peugeot 206 kopče za bočne ukrasne lajsne						
	boja	glava (mm)	tiplaØ (mm)	ukupna dužina (mm)	pakovanje /kom	fabrički broj	GRT Nr.
	bela	7,7x10	9	14,1	25	6995X3	182 016
	Peugeot 307 kopče za tapacir sa vrata						
	boja	glavaØ (mm)	tiplaØ (mm)	ukupna dužina (mm)	pakovanje /kom	fabrički broj	GRT Nr.
	bela	12,8	9	15,8	25	6991T3	182 017
	Citroen C3, C5, Peugeot 206, 306, 607 kopče za tapacir sa vrata						
	boja	glavaØ (mm)	tiplaØ (mm)	ukupna dužina (mm)	pakovanje /kom	fabrički broj	GRT Nr.
	bela	13	9	18	25	6991S6	182 018

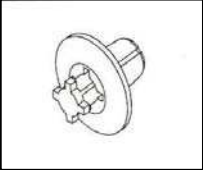

Citroen, Peugeot kopče

	Peugeot 307 kopče za podkrila						
	boja	glavaØ (mm)	tiplaØ (mm)	ukupna dužina (mm)	pakovanje /kom	fabrički broj	GRT Nr.
	crna	19,7	8	14	25	7013J0	182 019

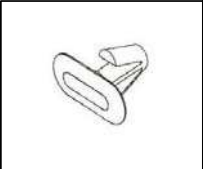
	Citroen Xsara, Peugeot 206, 307, 406 kopče za keder gume						
	boja	glava (mm)	tiplaØ (mm)	ukupna dužina (mm)	pakovanje /kom	fabrički broj	GRT Nr.
	crna	8x17	5	11,4	25	699786	182 020

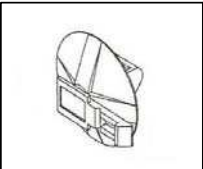
	Citroen, Peugeot kopče za fiksiranje kablova						
	boja	glava (mm)	tipla (mm)	visina (mm)	pakovanje /kom	fabrički broj	GRT Nr.
	crna	10,6x22,4	6x12	15,4	25	-	182 021

	Peugeot kopče za fiksiranje kablova						
	boja	mera (mm)	tiplaØ (mm)	visina (mm)	pakovanje /kom	fabrički broj	GRT Nr.
	crna	140x5,2	6,5	15,5	10	6997-71	182 022

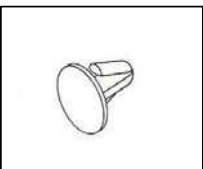
	Citroen Evasion, Peugeot 806 kopče za keder gumu						
	boja	glavaØ (mm)	tiplaØ (mm)	ukupna dužina (mm)	pakovanje /kom	fabrički broj	GRT Nr.
	crna	12,5	5	12	25	6999A3	182 023

	Citroen C4 kopče za bočne ukrasne lajsne						
	boja	glava (mm)	tiplaØ (mm)	ukupna dužina (mm)	pakovanje /kom	fabrički broj	GRT Nr.
	bela	7,6x8	8	17,5	25	856548	182 024

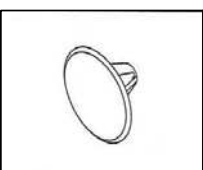
	Peugeot 307 kopče za izolaciju haube						
	boja	glavaØ (mm)	tiplaØ (mm)	ukupna dužina (mm)	pakovanje /kom	fabrički broj	GRT Nr.
	crna	20	6		25	6995V6	182 025

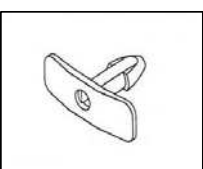
	Peugeot 307, 406 kopče za izolaciju haube						
	boja	glava (mm)	tiplaØ (mm)	ukupna dužina (mm)	pakovanje /kom	fabrički broj	GRT Nr.
	crna	8,2x18	4	13	25	871067	182 026

Citroen, Peugeot kopče

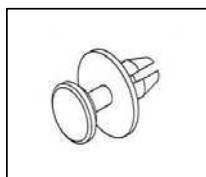

Citroen C2, C3, Peugeot 407 kopče za podkrila

boja	glavaØ (mm)	tiplaØ (mm)	ukupna dužina (mm)	pakovanje /kom	fabrički broj	GRT Nr.
crna	20	8	16	25	6991X7	182 027

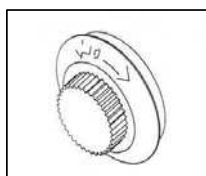

Peugeot HDI kopče za oblogu motora

boja	glavaØ (mm)	navojØ (mm)	visina (mm)	pakovanje /kom	fabrički broj	GRT Nr.
crna	27	6	11,3	5	13711	182 028

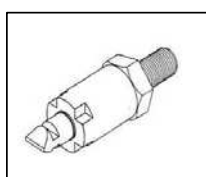

Peugeot HDI brezoni za kopče (182 028)

boja	navoj	tiplaØ (mm)	ukupna dužina (mm)	pakovanje /kom	fabrički broj	GRT Nr.
siva	M6	6	52	5	13723	182 029

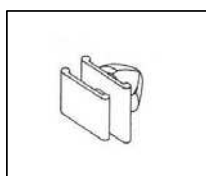

Peugeot 106, 206 kopče za bočne ukrasne lajsne

boja	glava (mm)	tiplaØ (mm)	ukupna dužina (mm)	pakovanje /kom	fabrički broj	GRT Nr.
crna	8x10	10	15,5	25	856534	182 030



Citroen, Peugeot univerzalne kopče za šraf od 3,5 mm

boja	glava (mm)	tipla (mm)	ukupna dužina (mm)	pakovanje /kom	fabrički broj	GRT Nr.
bezb.	13x20	7x13,5	17,5	25	699796	182 031

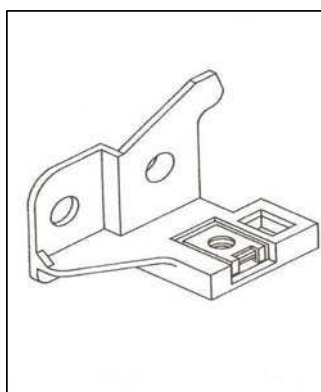

Citroen Xsara 2001 kopče za pričvršćivanje fara, desni

pakovanje /kom	fabrički broj	GRT Nr.
1	621258	182 032

Citroen, Peugeot kopče

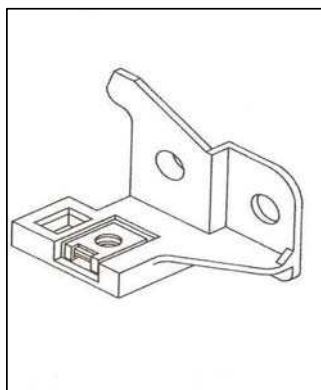

Citroen Xsara 2001 kopče za pričvršćivanje fara, leva

pakovanje /kom	fabrički broj	GRT Nr.
1	621257	182 033



Peugeot 206 kopče za pričvršćivanje zadnje metlice

boja	glavaØ (mm)	tiplaØ (mm)	ukupna dužina (mm)	pakovanje /kom	fabrički broj	GRT Nr.
sreb.	20	7,5	30	10	6973A4	182 034



Citroen, Peugeot kopče za poklopac motora

boja	glavaØ (mm)	tiplaØ (mm)	ukupna dužina (mm)	pakovanje /kom	fabrički broj	GRT Nr.
sreb.	16	4x6,4	24	10	703016	182 050



Citroen, Peugeot kopče za poklopac motora

boja	glava (mm)	tipla (mm)	visina (mm)	pakovanje /kom	fabrički broj	GRT Nr.
sreb.	9x23	10x11	9,7	10	703018	182 051



Peugeot kopče za tapacir

boja	glavaØ (mm)	tiplaØ (mm)	ukupna dužina (mm)	pakovanje /kom	fabrički broj	GRT Nr.
crna	20	8	15,8	25	856553	185 018

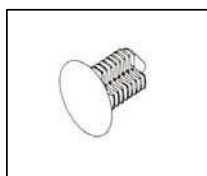

Citroen Berlingo I., II., Peugeot Partner I., II. kopče za tapacir



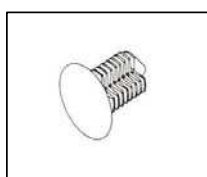

boja	glavaØ (mm)	tiplaØ (mm)	ukupna dužina (mm)	pakovanje /kom	fabrički broj	GRT Nr.
crna	14	7	17,4	25	896457	186 000



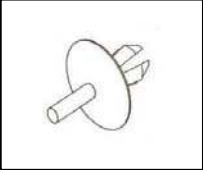

Citroen Berlingo I., II., Peugeot Partner I., II. kopče za tapacir

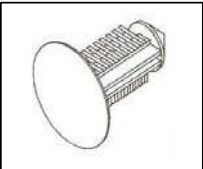
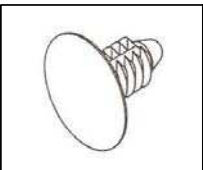
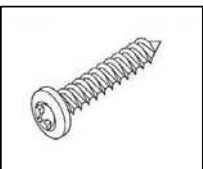
boja	glavaØ (mm)	tiplaØ (mm)	ukupna dužina (mm)	pakovanje /kom	fabrički broj	GRT Nr.
siva	14	7	17,4	25	-	186 001

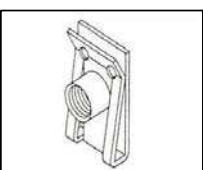
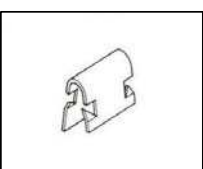
Citroen, Peugeot kopče

	Citroen, Peugeot kopče za tapacir						
	boja	glavaØ (mm)	tiplaØ (mm)	ukupna dužina (mm)	pakovanje /kom	fabrički broj	GRT Nr.
	crna	16	5,5	13,2	25	-	186 032
	Citroen Xantia kopče za tapacir						
	boja	glavaØ (mm)	tiplaØ (mm)	ukupna dužina (mm)	pakovanje /kom	fabrički broj	GRT Nr.
	crna	30	5	17,2	25	-	187 030
	Peugeot 307 kopče za podkrila						
	boja	glavaØ (mm)	tiplaØ (mm)	ukupna dužina (mm)	pakovanje /kom	fabrički broj	GRT Nr.
	crna	16	8	22	25	-	187 036
	Citroen Xsara kopče za tapacir						
	boja	glavaØ (mm)	tiplaØ (mm)	ukupna dužina (mm)	pakovanje /kom	fabrički broj	GRT Nr.
	crna	17,7	7	17,6	25	-	187 210
	Peugeot univerzalni Torx šraf za lim						
	boja	glavaØ (mm)	navoj (mm)	ukupna dužina (mm)	pakovanje /kom	fabrički broj	GRT Nr.
	crna	9,6	4,2	16	50	-	190 127
	Peugeot univerzalni Torx šraf za lim						
	boja	glavaØ (mm)	navoj (mm)	ukupna dužina (mm)	pakovanje /kom	fabrički broj	GRT Nr.
	crna	11,3	4,8	16	50	-	190 130
	Peugeot univerzalna limena matica sa metričkim navojem						
	šraf	mera (mm)	za lim (mm)	sred.rupa (mm)	pakovanje /kom	fabrički broj	GRT Nr.
	M6	23,9x16,1	0,9-4,3	12,5	25	-	191 226
	Peugeot metalne kopče za tapacir						
	boja	mera (mm)	za lim (mm)	debljina (mm)	pakovanje /kom	fabrički broj	GRT Nr.
	sreb.	9,6x12,2	1,7-2,9	4,4	100	-	191 325

Citroen, Peugeot kopče

	Citroen AX, Berlingo, Xantia, ZX Peugeot 106,306,405, Partner šraf za karter						
	boja	glava (mm)	navoj	teljes hossz (mm)	pakovanje /kom	fabrički broj	GRT Nr.
	sreb.	21	M14x1,25	17,2	5	-	191 341
	Citroen AX, BX, C15, Peugeot J5 šraf za karter						
	boja	glavaØ (mm)	navoj	ukupna dužina (mm)	pakovanje /kom	fabrički broj	GRT Nr.
	sreb.	22	M16x1,5	16,8	5	-	191 347
	Peugeot 205, 309, 405, Talbot šraf za karter						
	boja	glavaØ (mm)	navoj	ukupna dužina (mm)	pakovanje /kom	fabrički broj	GRT Nr.
	žuta	25	M20x1,5	13,7	5	-	191 349