

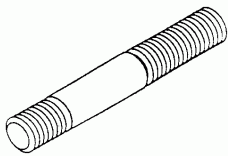
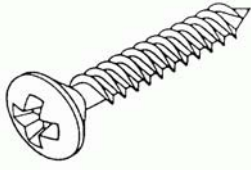

	Mera/mm	kom./pak	GRT Šifra
	M8*35	25	105 040
	M8*45	25	105 042
	M8*60	25	105 044

Vijkovi za lim sa D glavom DIN 7981 (pocink)

	2,9*13	100	190 000
	3,5*16	100	190 001
	3,5*19	100	190 002
	3,5*25	100	190 003
	3,9*16	100	190 004
	3,9*19	100	190 005
	3,9*25	100	190 006
	4,2*16	100	190 007
	4,2*19	100	190 008
	4,2*25	100	190 009
	4,8*19	100	190 010
4,8*38	50	190 011	

Vijkovi za lim sa D glavom DIN 7981 (pocink)

	2,9*9,5	100	190 025
	2,9*13	100	190 026
	3,5*9,5	100	190 027
	3,5*13	100	190 028
	3,5*16	100	190 029
	3,5*19	100	190 030
	3,5*25	100	190 031
	3,9*13	100	190 032
	3,9*16	100	190 033
	3,9*19	100	190 034
	3,9*25	100	190 035
	4,2*9,5	100	190 036
	4,2*13	100	190 037
	4,2*16	100	190 038
	4,2*19	100	190 039
	4,2*25	100	190 040
	4,2*32	100	190 041
	4,2*38	100	190 042
4,8*13	100	190 043	
4,8*16	100	190 044	
4,8*19	100	190 045	
4,8*25	100	190 046	
4,8*38	50	190 047	
5,5*19	50	190 048	
6,3*19	50	190 049	

Vijkovi za lim sa D glavom DIN 7981 (crni)

	2,9*13	100	190 075
	3,5*16	100	190 076
	3,5*25	100	190 077
	3,5*38	100	190 078
	4,2*13	100	190 079
	4,2*16	100	190 080
	4,2*25	100	190 081
	4,2*50	50	190 082
	4,8*16	100	190 083
	4,8*25	100	190 084

Vijak za lim sa širokom podloškom (crni)

	4,2*13	25	190 090
	4,8*13	25	190 091
	4,8*19	25	190 093

	Mera/mm	kom./pak	GRT Šifra
Vijak za lim sa širokom glavom (crni)			
	3,5*16	50	190 100
	3,9*19	50	190 101
	4,2*16	50	190 102
	4,2*19	50	190 103
	4,2*22	50	190 104
	4,8*16	50	190 105
	4,8*19	50	190 106
	4,8*25	50	190 107

Torx vijak za lim sa širokom glavom (crni)			
	3,5*16	50	190 125
	3,5*19	50	190 126
	4,2*16	50	190 127
	4,2*19	50	190 128
	4,2*25	50	190 129
	4,8*16	50	190 130
	4,8*22	50	190 131

Imbus vijak sa širokom glavom (pocink)			
	M5*16	25	190 138
	M5*20	25	190 139
	M6*16	25	190 140

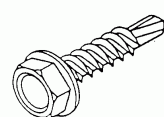
Vijak za lim sa šestougaonom glavom DIN 7504 (pocink)			
	3,9*16	50	190 150
	4,2*16	50	190 151
	4,8*16	50	190 152

Vijak za lim (pocink)			
	4,2*13	50	190 160
	4,2*16	50	190 161
	4,2*19	50	190 162

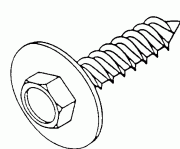
Vijak za lim sa širokom podloškom (pocink)			
	4,8*19	100	190 175
	5,5*19	100	190 176
	6,3*19	100	190 177

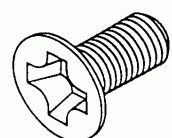
Vijak sa upuštajućom glavom DIN 965 4,8 (pocink)			
	M4*16	100	190 225
	M4*25	100	190 226
	M5*20	100	190 227
	M5*30	100	190 228
	M6*12	100	190 229
	M6*16	100	190 230
	M6*20	100	190 231
	M6*30	100	190 232
	M8*16	50	190 233
	M8*20	50	190 234
	M8*25	50	190 235
	M8*30	50	190 236

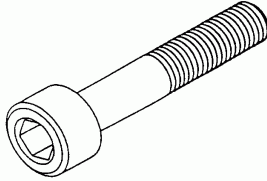
	Mera/mm	kom./pak	GRT Šifra
Imbus vijkovi DIN 912 8,8 (pocink)			
	M4*10	100	190 250
	M4*16	100	190 251
	M4*20	100	190 252
	M5*10	100	190 253
	M5*16	100	190 254
	M5*20	100	190 255
	M5*25	100	190 256
	M6*10	50	190 257
	M6*16	50	190 258
	M6*20	50	190 259
	M6*25	50	190 260
	M6*30	50	190 261
	M6*40	50	190 262
	M8*16	50	190 263
	M8*20	50	190 264
	M8*25	50	190 265
	M8*30	50	190 266
	M8*40	50	190 267
	M8*50	50	190 268
	M10*20	50	190 269
M10*25	50	190 270	
M10*30	50	190 271	
M10*40	50	190 272	
M10*50	50	190 273	

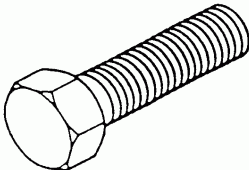
	Mera/mm	kom./pak	GRT Šifra
Mašinski vijkovi DIN 933 8,8 (pocink)			
	M4*16	100	190 300
	M4*20	100	190 301
	M5*16	100	190 302
	M5*20	100	190 303
	M5*30	100	190 304
	M6*16	100	190 305
	M6*20	100	190 306
	M6*25	100	190 307
	M6*30	50	190 308
	M6*40	50	190 309
	M6*50	50	190 310
	M8*16	50	190 311
	M8*20	50	190 312
	M8*25	50	190 313
	M8*30	50	190 314
	M8*40	50	190 315
	M8*50	25	190 316
	M8*60	25	190 317
	M8*70	25	190 318
	M10*25	25	190 319
	M10*30	25	190 320
	M10*40	25	190 321
	M10*50	25	190 322
	M10*60	25	190 323
M12*30	25	190 324	
M12*40	25	190 325	
M12*50	25	190 326	
M12*60	25	190 327	

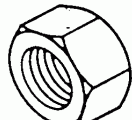
	Mera/mm	kom./pak	GRT Šifra
Matice DIN 934 8,8 (pocink)			
	M4	100	190 350
	M5	100	190 351
	M6	100	190 352
	M8	50	190 353
	M10	50	190 354
M12	50	190 355	

	Mera/mm	kom./pak	
Matice sa samokočijućom podloškom DIN 6923 8,8 (pocink)			
	M5	100	190 375
	M6	100	190 376
	M8	50	190 377
	M10	50	190 378
	M12	25	190 379

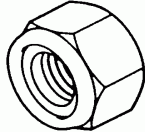
Matice samokočijuće DIN 985 8,8 (pocink)			
	M5	25	190 400
	M6	25	190 401
	M8	25	190 402
	M10*1	25	190 403
	M10*1,25	25	190 404
	M10*1,5	25	190 405
	M12*1	25	190 406
	M12*1,25	25	190 407
	M12*1,5	25	190 408
	M14*1,5	10	190 409
M16*1,5	10	190 410	

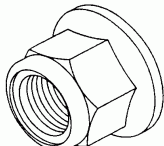
Matice samokočijuće sa podloškom DIN 6926 8,8 (pocink)			
	M5	25	190 415
	M6	25	190 416
	M8	25	190 417
	M10	10	190 418
	M12	10	190 419
	M16	10	190 420

Nitne (aluminijum)			
	M4	50	190 425
	M5	50	190 426
	M6	50	190 427
	M8	50	190 428

Nitne (čelik,pocink)			
	M4	50	190 450
	M5	50	190 451
	M6	50	190 452
	M8	50	190 453

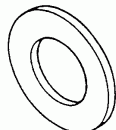
Podloške DIN 125 (pocink)			
	M4	100	190 475
	M5	100	190 476
	M6	100	190 477
	M8	100	190 478
	M10	50	190 479
	M12	50	190 480

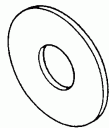
Široke podloške DIN 9021 (pocink)			
	M4	100	190 500
	M5	100	190 501
	M6	100	190 502
	M8	100	190 503
	M10	50	190 504
	M12	50	190 505

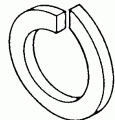
Oprugaste podloške DIN 127 (pocink)			
	M4	100	190 525
	M5	100	190 526
	M6	100	190 527
	M8	50	190 528
	M10	50	190 529
	M12	50	190 530

Mera/mm kom./pak

Podloške sa unutrašnjim zubima DIN 6798 (pocink)



M4	100	190 550
M5	100	190 551
M6	100	190 552
M8	50	190 553
M10	50	190 554
M12	50	190 555

Podloške sa unutrašnjim zubima (pocink)

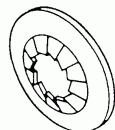

M4*11	100	190 575
M5*16	100	190 576
M6*18	100	190 577
M8*26	50	190 578

Podloške (pocink)



M3	100	190 600
M4	100	190 601
M5	100	190 602
M6	100	190 603

Bakarne podloške DIN 7603

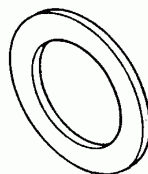

6*10*1	100	190 625
6*12*1	100	190 626
8*12*1	100	190 627
8*14*1	100	190 628
10*14*1	100	190 629
10*16*1	100	190 630
12*16*1,5	100	190 631
12*18*1,5	100	190 632
14*18*1,5	100	190 633
14*20*1,5	100	190 634
16*20*1,5	100	190 635
16*22*1,5	100	190 636
18*22*1,5	100	190 637
18*24*1,5	100	190 638
20*26*1,5	100	190 639
22*27*1,5	100	190 640
24*30*1,5	100	190 641
26*32*2	50	190 642
30*36*2	50	190 643
32*38*2	50	190 644

Aluminijumske podloške DIN 7603

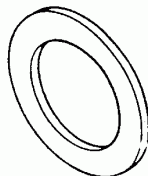

6*10*1	100	190 675
6*12*1	100	190 676
8*12*1	100	190 677
8*14*1	100	190 678
10*14*1	100	190 679
10*16*1	100	190 680
12*16*1,5	100	190 681
12*18*1,5	100	190 682
14*18*1,5	100	190 683
14*20*1,5	100	190 684
16*20*1,5	100	190 685
16*22*1,5	100	190 686
18*22*1,5	100	190 687
18*24*1,5	100	190 688
20*24*1,5	100	190 689
20*26*1,5	100	190 690
22*27*1,5	100	190 691
24*30*2	100	190 692
27*32*2	50	190 693
30*36*2	50	190 694

Bakarne podloške

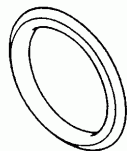

Mera/mm	kom./pak	GRT Šifra
6*10*1,5	50	190 725
8*14*1,5	50	190 726
10*16*1,5	50	190 727
12*18*2	50	190 728
14*20*2	50	190 729
16*22*2	50	190 730
18*24*2	50	190 731
20*26*2	50	190 732
22*27*2	50	190 733
26*32*2,5	50	190 734

O-Ring prstenovi otporni na ulje

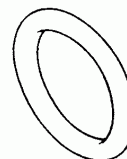

3,69*1,78	25	190 750
4,47*1,78	25	190 751
5,28*1,78	25	190 752
6,07*1,78	25	190 753
7,66*1,78	25	190 754
9,25*1,78	25	190 755
9,19*2,62	25	190 756
10,78*2,62	25	190 757
12,37*2,62	25	190 758
13,95*2,62	25	190 759
15,54*2,62	25	190 760
17,13*2,62	25	190 761
18,72*2,62	25	190 762
18,64*3,53	25	190 763
20,22*3,53	25	190 764
23,40*3,53	25	190 765
25,00*3,53	25	190 766
26,57*3,53	25	190 767
28,17*3,53	25	190 768
31,34*3,53	25	190 769
34,52*3,53	25	190 770
36,10*3,53	25	190 771
37,47*5,34	25	190 772
40,65*5,34	25	190 773

Seeger prstenovi DIN 471 (spoljni)

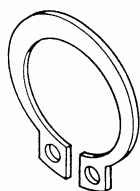

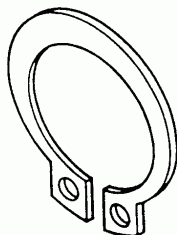

6*0,7	50	190 800
8*0,8	50	190 801
10*1	50	190 802
11*1	50	190 803
12*1	50	190 804
14*1	50	190 805
15*1	50	190 806
16*1	50	190 807

Seeger prstenovi DIN 471 (spoljni)

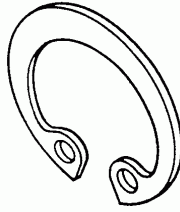

17*1	50	190 808
18*1,2	50	190 809
20*1,2	25	190 810
22*1,2	25	190 811
24*1,2	25	190 812
25*1,2	25	190 813
26*1,2	25	190 814
28*1,5	25	190 815
30*1,5	25	190 816
32*1,5	25	190 817
34*1,5	25	190 818
35*1,5	25	190 819
40*1,75	25	190 820

	Mera/mm	kom./pak	GRT Šifra
Seeger prstenovi DIN 472 (unutrašnji)			
	10*1	50	190 850
	13*1	50	190 851
	15*1	50	190 852
	16*1	50	190 853
	18*1	50	190 854
	19*1	50	190 855
	20*1	25	190 856
	22*1	25	190 857
	24*1,2	25	190 858
	25*1,2	25	190 859
	26*1,2	25	190 860
	27*1,2	25	190 861
	28*1,2	25	190 862
	30*1,2	25	190 863
	32*1,2	25	190 864
	34*1,5	25	190 865
	35*1,5	25	190 866
	36*1,5	25	190 867
	37*1,5	25	190 868
	38*1,5	25	190 869
40*1,75	25	190 870	

Osigurač prsten DIN 6799			
	4*0,7	50	190 900
	5*0,7	50	190 901
	6*0,7	50	190 902
	8*1	50	190 903

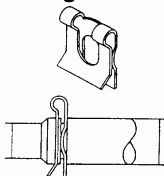
Limeni osigurač			
	8*0,4	25	190 910

Limeni osigurači			
	3*0,3	50	190 925
	4*0,3	50	190 926
	5*0,3	50	190 927

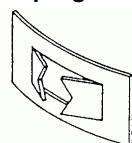
Limene opruge			
	3,5*0,4	25	190 950
	5*0,4	25	190 951

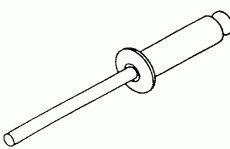
Popnitne DIN 7337 (aluminijum)			
	3,2*8	100	190 978
	3,2*10	100	190 979
	3,2*12	100	190 980
	3,9*10	100	190 985
	3,9*16	100	190 987
	4,8*12	100	190 991
	4,8*16	100	190 993
4,8*20	100	190 995	

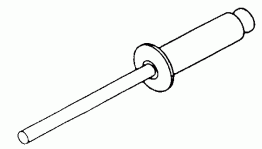
	Mera/mm	kom./pak	GRT Šifra
Popnitne DIN 7337 (čelik,pocink)			
	3,9*10	100	191 034
	4,8*12	100	191 038

Popnitne - Širokoglava (aluminijum)

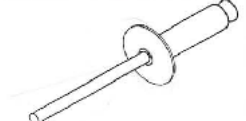
	4,8*16	14Ø	100	191 050
---	--------	-----	-----	---------

Osigurači DIN 7346

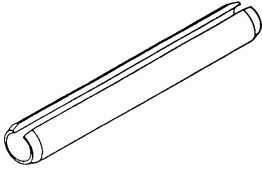
	3*30	25	191 075
	3*40	25	191 076
	4*20	25	191 077
	4*30	25	191 078
	4*40	25	191 079
	4*50	25	191 080
	5*30	25	191 081
	5*40	25	191 082
	5*50	25	191 084
	6*30	25	191 085
	6*40	25	191 086
	6*50	25	191 087
	6*60	25	191 088
	8*40	25	191 089
	8*50	25	191 090
8*60	25	191 091	
8*70	25	191 092	
10*50	25	191 093	
10*60	25	191 094	

Osigurači DIN 94 (pocink)

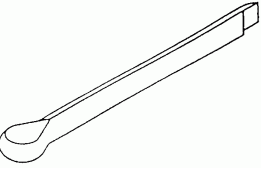
	1,0*20	100	191 100
	1,6*32	100	191 101
	2,0*32	100	191 102
	2,5*32	100	191 103
	2,5*40	100	191 104
	3,2*32	100	191 105
	3,2*40	100	191 106
	3,2*50	100	191 107
	3,5*40	100	191 108
	4,0*40	100	191 109
	4,5*50	50	191 110
	5,0*50	50	191 111
	5,0*80	50	191 112
	6,3*63	50	191 113

Oprugasti osigurači DIN 11024 (pocink)

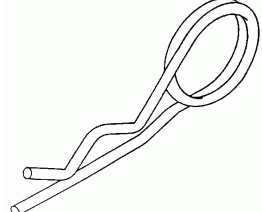
	3	10	191 118
	4	10	191 119
	5	10	191 120
	6	10	191 121

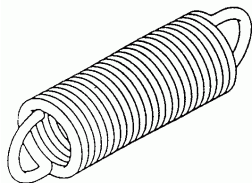
	Mera/mm	kom./pak	GRT Šifra
Opruge DIN 2097 (pocink)			
	4,7*25*0,7	10	191 330
	6,7*30*0,7	10	191 331
	8,0*35*1,0	10	191 332
	10,0*40*1,0	10	191 333
	10,0*50*1,5	10	191 334
	14,0*60*1,5	10	191 335
	14,0*75*2,0	10	191 336
	17,0*100*2,25	10	191 337

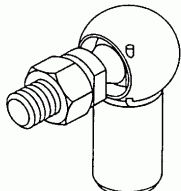
	Mera	kom./pak	GRT Šifra
Zglob DIN 71802 AS (desni navoj)			
	M5	5	191 310
	M6	5	191 311
	M8	5	191 312
	M10	5	191 313

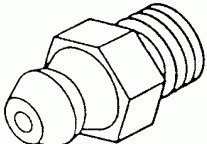
	Mera	kom./pak	GRT Šifra
Mazalice DIN 71412 (pocink)			
	M6*1	100	191 125
	M8*1	50	191 126
	M10*1	50	191 127

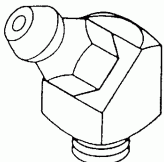
	Mera	kom./pak	GRT Šifra
Mazalice pod 45 stepeni DIN 71412 (pocink)			
	M6*1	50	191 150
	M8*1	50	191 151
	M10*1	50	191 152

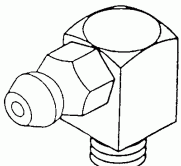
	Mera	kom./pak	GRT Šifra
Mazalice pod 90 stepeni DIN 71412 (pocink)			
	M6*1	50	191 175
	M8*1	50	191 176
	M10*1	50	191 177

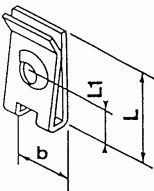
	Mera	L	b	L1	F	kom./pak	GRT Šifra
Limena matica (pocink,žuta)							
	2,9	9,9	8,0	4,6	0,5-1,2	100	191 200
	3,9	16,5	11,0	8,6	0,5-1,7	100	191 199
	4,2	12,5	11,0	6,0	2,2-2,7	100	191 201
	4,2	16,5	11,0	7,9	0,5-1,7	100	191 202
	4,8	19,3	12,5	9,5	2,5-3,4	100	191 203
	4,8	20,0	12,5	9,5	0,9-2,0	100	191 204
	4,8	19,7	16,0	7,3	0,8-1,7	100	191 205
	4,8	20,4	15,0	11,4	0,5-4,5	100	191 210
	5,6	20,8	13,0	8,8	0,7-1,5	50	191 206
	6,3	24,8	16,0	10,5	0,7-1,5	50	191 207

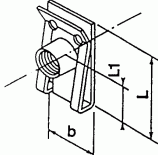
	Mera	L	b	L1	F	kom./pak	GRT Šifra
Limene matice sa metričkim navojem(pocink)							
	M5	21,7	14,5	11,5	0,9-4,8	25	191 225
	M6	23,9	16,1	12,5	0,9-4,3	25	191 226
	M8	24,3	16,6	14,5	0,5-4,0	25	191 227

Limena matica (pocink)

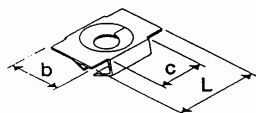

Mera	L	b	c	F	kom./pak	
4,2	15	9	7,8	1,5-2,0	100	191 215

Četvrtaste limene matice (pocink)

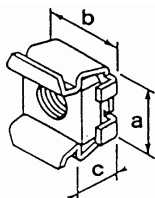

Mera	a	b	c	F	kom./pak	
M5	11,7	12,0	5,8	0,5-2,0	25	191 249
M6	12,6	13,1	6,4	0,7-1,7	25	191 250
M8	16,1	16,4	7,8	0,7-3,2	25	191 251

Četvrtaste limene matice (pocink)

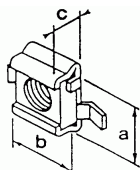

Mera	a	b	c	F	kom./pak	
M4	12,0	12,7	5,6	0,7-1,7	25	191 275
M6	11,5	12,6	6,3	0,7-1,7	25	191 276
M8	16,0	19,1	7,4	0,7-2,0	25	191 277

Limene matice (pocink)

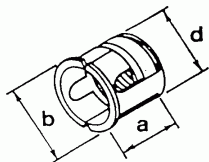

Mera	a	b	d	F	kom./pak.	
M4	13,0	11,5	10,2	0,7-4,0	25	191 299
M5	13,0	11,5	10,2	0,7-4,0	25	191 300
M6	13,0	11,5	10,2	0,7-4,0	25	191 301

Torx vijak sa širokom glavom (crna)



M8*15	25	191 800
-------	----	---------

Set vijkova za lim i limenih matica

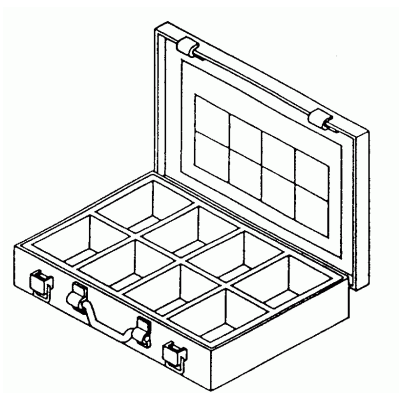

Mera/mm kom./pak. GRT Šifra

Sastav-kom/set 600
GRT Šifra / set 192 000

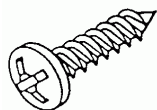

3.9*16 100 190 033

4.8*19 100 190 045

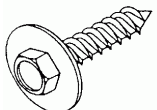

4.8*19 50 190 175

5.5*19 50 190 176

6.3*19 50 190 177

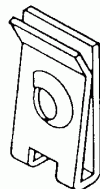

4.2 100 191 202

4.8 100 191 204

6.3 50 191 207

Set matica samokočijuća DIN 985 8,8

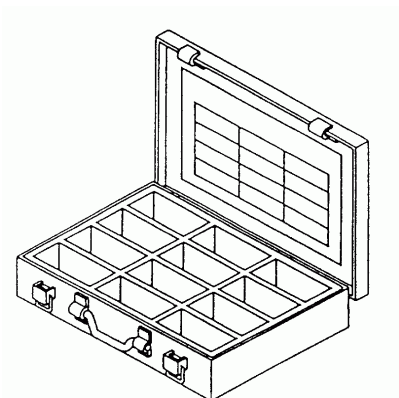

Sastav-kom/set 320
GRT Šifra / set 192 001

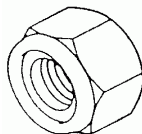

M5 50kom 190 400

M6 50kom 190 401

M8 50kom 190 402

M10*1 25kom 190 403

M10*1,25 25kom 190 404

M10*1,5 25kom 190 405

M12*1 25kom 190 406

M12*1,25 25kom 190 407

M12*1,5 25kom 190 408

M14*1,5 10kom 190 409

M16*1,5 10kom 190 410

Mera/mm kom./pak.

GRT Šifra

Set bakarnih podloški DIN 7603

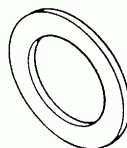
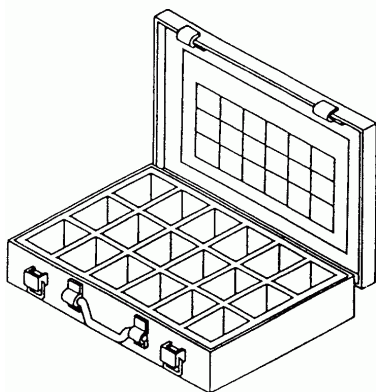

Sastav-kom/set 735
GRT Šifra / set 192 002

6*10*1	50kom	190 625
6*12*1	50kom	190 626
8*12*1	50kom	190 627
8*14*1	50kom	190 628
10*14*1	50kom	190 629
10*16*1	50kom	190 630
12*16*1,5	50kom	190 631
12*18*1,5	50kom	190 632
14*18*1,5	50kom	190 633
14*20*1,5	50kom	190 634
16*20*1,5	50kom	190 635
16*22*1,5	50kom	190 636
18*24*1,5	25kom	190 638
20*26*1,5	25kom	190 639
22*27*1,5	25kom	190 640
26*32*2	25kom	190 642
30*36*2	25kom	190 643
32*38*2	10kom	190 644

Set aluminijumskih podloški DIN 7603

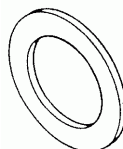
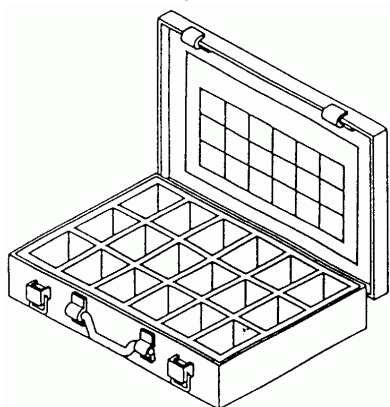

Sastav-kom/set 750
GRT Šifra / set 192 003

6*10*1	50kom	190 675
6*12*1	50kom	190 676
8*12*1	50kom	190 677
8*14*1	50kom	190 678
10*14*1	50kom	190 679
10*16*1	50kom	190 680
12*16*1,5	50kom	190 681
12*18*1,5	50kom	190 682
14*18*1,5	50kom	190 683
14*20*1,5	50kom	190 684
16*20*1,5	50kom	190 685
16*22*1,5	50kom	190 686
18*24*1,5	25kom	190 688
20*26*1,5	25kom	190 690
22*27*1,5	25kom	190 691
24*30*2	25kom	190 692
27*32*2	25kom	190 693
30*36*2	25kom	190 694

Mera/mm kom./pak. GRT Šifra

Set aluminijumskih podloški DIN 7603

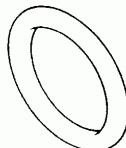
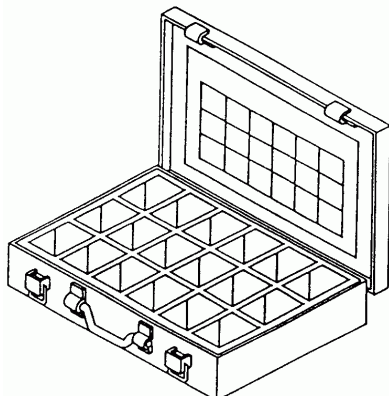

Sastav-kom/set 416
GRT Šifra / set 192 004

3,69*1,78	25kom	190 750
4,47*1,78	25kom	190 751
5,28*1,78	25kom	190 752
6,07*1,78	25kom	190 753
7,66*1,78	25kom	190 754
9,25*1,78	25kom	190 755
9,19*2,62	25kom	190 756
10,78*2,62	25kom	190 757
12,37*2,62	25kom	190 758
13,95*2,62	25kom	190 759
15,54*2,62	25kom	190 760
17,13*2,62	25kom	190 761
18,72*2,62	10kom	190 762
18,64*3,53	10kom	190 763
20,22*3,53	10kom	190 764
23,40*3,53	10kom	190 765
25,00*3,53	10kom	190 766
26,57*3,53	10kom	190 767
28,17*3,53	10kom	190 768
31,34*3,53	10kom	190 769
34,52*3,53	10kom	190 770
36,10*3,53	10kom	190 771
37,47*5,34	8kom	190 772
40,65*5,34	8kom	190 773

Set Seeger prstena DIN 471(spoljni)

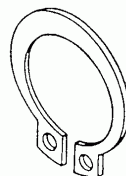
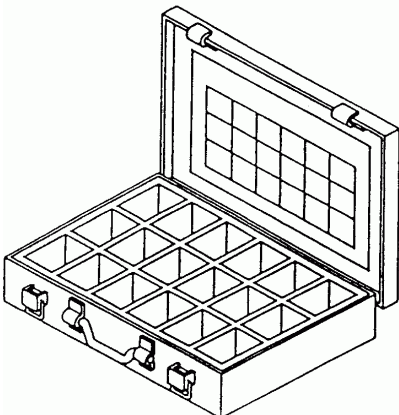

Sastav-kom/set 650
GRT Šifra / set 192 005

8*0,8	50kom	190 801
10*1	50kom	190 802
12*1	50kom	190 804
14*1	50kom	190 805
15*1	50kom	190 806
16*1	50kom	190 807
17*1	50kom	190 808
18*1,2	50kom	190 809
20*1,2	25kom	190 810
22*1,2	25kom	190 811
24*1,2	25kom	190 812
25*1,2	25kom	190 813
26*1,2	25kom	190 814
28*1,5	25kom	190 815
30*1,5	25kom	190 816
32*1,5	25kom	190 817
35*1,5	25kom	190 819
40*1,75	25kom	190 820

Set Seeger prstenova DIN 472 (unutrašnja)

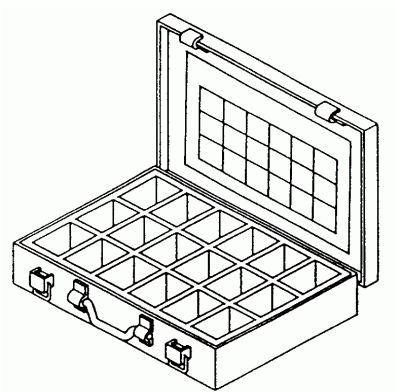

Mera/mm kom./pak. GRT Šifra

Sastav-kom/set 500
 GRT Šifra / set 192 006

13*1	50kom	190 851
15*1	50kom	190 852
16*1	50kom	190 853
18*1	50kom	190 854
20*1	50kom	190 856
22*1	25kom	190 857
24*1,2	25kom	190 858
25*1,2	25kom	190 859
26*1,2	25kom	190 860
28*1,2	25kom	190 862
30*1,2	25kom	190 863
32*1,2	25kom	190 864
34*1,5	25kom	190 865
35*1,5	25kom	190 866
36*1,5	25kom	190 867
37*1,5	25kom	190 868
38*1,5	25kom	190 869
40*1,75	25kom	190 870

Set osigurača DIN 7346

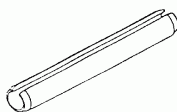
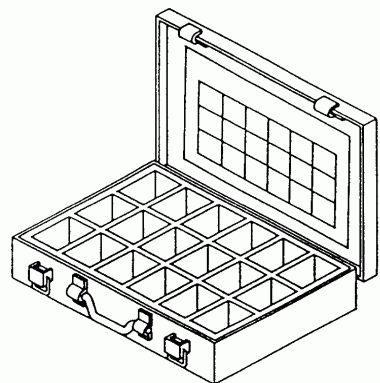

Sastav-kom/set 670
 GRT Šifra / set 192 007

3*30	50kom	191 075
3*40	50kom	191 076
4*20	50kom	191 077
4*30	50kom	191 078
4*40	50kom	191 079
4*50	50kom	191 080
5*30	50kom	191 081
5*40	50kom	191 082
5*50	25kom	191 084
6*30	50kom	191 085
6*40	50kom	191 086
6*50	25kom	191 087
6*60	25kom	191 088
8*40	25kom	191 089
8*50	25kom	191 090
8*60	25kom	191 091
10*50	10kom	191 093
10*60	10kom	191 094

Mera/mm kom./pak. GRT Šifra

Set Osigurača DIN 94 (pocink)

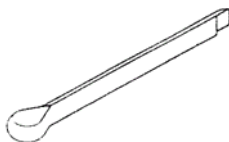
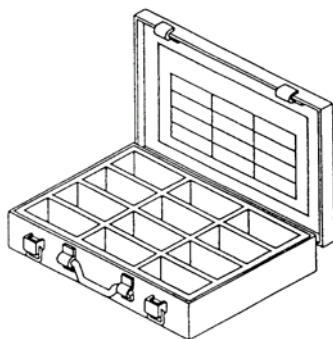

Sastav-kom/set **1025**
GRT Šifra / set **192 008**

1,0*20	100kom	191 100
1,6*32	100kom	191 101
2,0*32	100kom	191 102
2,5*32	100kom	191 103
2,5*40	100kom	191 104
3,2*32	100kom	191 105
3,2*50	100kom	191 107
3,5*40	100kom	191 108
4,0*40	100kom	191 109
4,5*50	50kom	191 110
5,0*50	50kom	191 111
6,3*63	25kom	191 112

Metalni kofer sa pregradama 335*235*55 mm

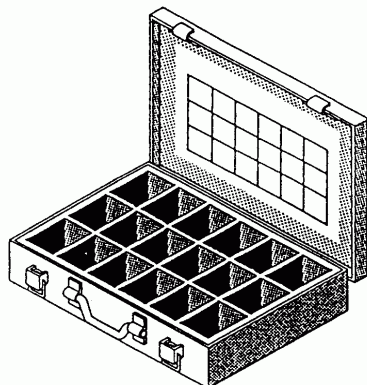

sa 8 plastičnih pregrada **100 613**

sa 12 plastičnih pregrada **100 614**

sa 18 plastičnih pregrada **100 615**

Metalni ormar 380*355*365 mm

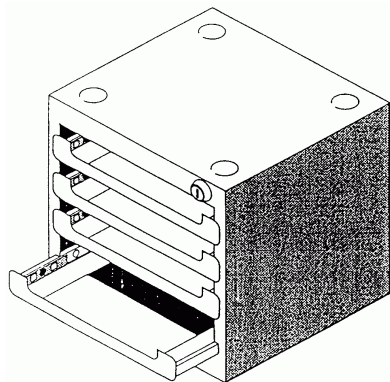

sa 4 fioke (sa bravicom) **100 616**

Fioke sa metalni kućištem 283*305*150

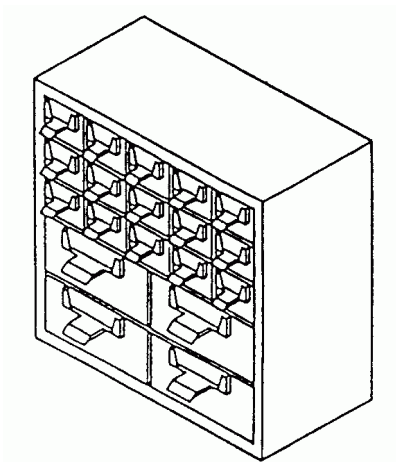

Naziv	(boja plava)	
15 kom malih fioka i 4kom vel.		100 563
30 kom malih fioka		100 565
8 kom velikih fioka		100 562

Fioke sa metalnim kućištem 555*305*150

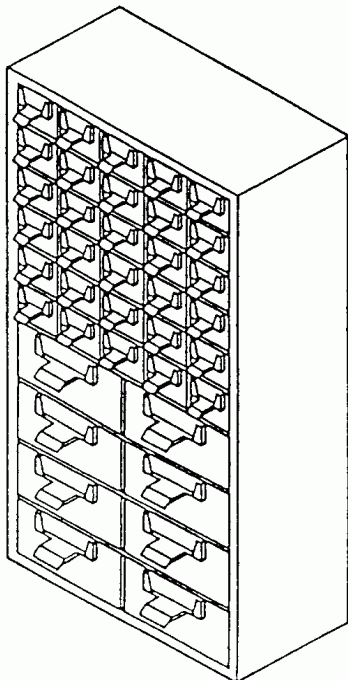

Naziv	(boja plava)	
30 kom malih fioka i 8 kom vel.		100 564
60 kom malih fioka		100 560
16 kom velikih fioka		100 561

Metalni držači za robu

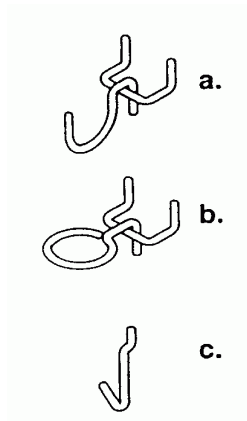

Naziv	mara/mm	GRT Sifra
držač (a)	27	111 050
držač (b)	35	111 051
držač (c)	27	111 052

Metalni držači za robu

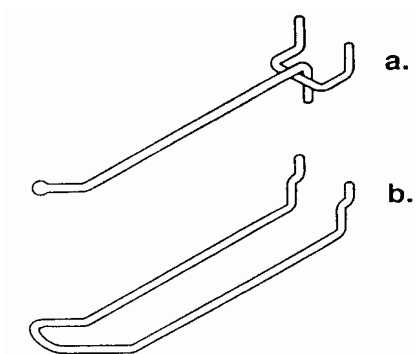

simpla (a)	60	112 003
simpla (a)	80	112 006
simpla (a)	160	112 005
simpla (a)	200	112 007
dupla (b)	150	111 040
dupla (b)	200	111 041

Metalni držači za robu

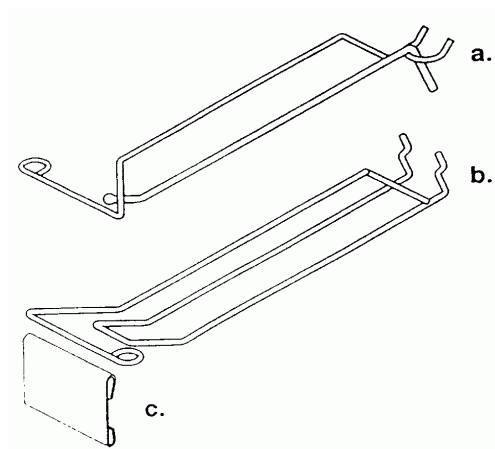

simpla (a)	300	111 049
dupla (b)	300	111 048
držac (c)	65*45	111 055

**"SM" Šelne* W1
Gemi**

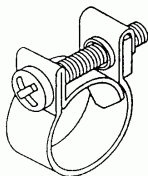

Mera/mm	kom./pak	GRT Sifra
8/9	50	199 800
9/9	50	199 801
10/9	50	199 802
11/9	50	199 803
12/9	50	199 804
13/9	50	199 805
14/9	50	199 806

**"SX" Šelne W1* DIN 3017
Gemi**

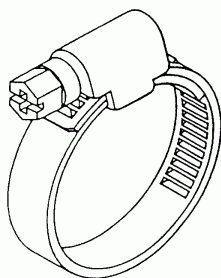

širina 9 mm

8-12/9	100	199 950
10-16/9	100	199 951
12-20/9	100	199 952
16-25/9	100	199 953
20-32/9	100	199 954
25-40/9	100	199 955
30-45/9	100	199 956
32-50/9	50	199 957
40-60/9	50	199 958
50-70/9	50	199 959
60-80/9	25	199 960
70-90/9	25	199 961
80-100/9	25	199 962
90-110/9		199 963
100-120/9		199 964
110-130/9		199 965
120-140/9		199 966
130-150/9		199 967
140-160/9		199 968

"KVP" Šelne W2B*

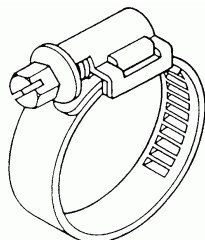

širina 9 mm

10-16/9	100	200 400
12-20/9	100	200 401
16-28/9	100	200 402
20-32/9	100	200 403
25-40/9	100	200 404
32-50/9	50	200 405
40-60/9	50	200 407
50-70/9	50	200 406
60-80/9	25	200 408

*W1 Vijak i kućište od pocinkovanog čelika

*W2B traka od chromiranog čelika, vijak i kućište od pocinkovanog lima

"SX" Šelne W1* DIN 3017 W1*

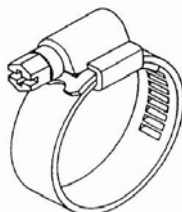

16-25/12	50	199 855
20-32/12	50	199 856
25-40/12	50	199 857
32-50/12	50	199 858
40-60/12	25	199 859
50-70/12	25	199 860
60-80/12	25	199 861
70-90/12	25	199 862

širina 12mm

"FG" Šelne za manžetne W4*



25-50/7	199 895
40-110/7	199 896

širina 7mm

"SDO" Šelna W1*

Gemü

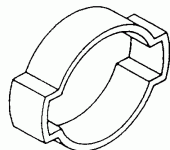

Širina 9mm

Mera/mm	kom./pak	GRT Šifra
9-11/9	25	199 922
11-13/9	25	199 923
13-15/9	25	199 924
14-17/9	25	199 925
15-18/9	25	199 926
17-20/9	25	199 927
18-21/9	25	199 928
20-23/9	25	199 929
22-25/9	25	199 930

*W1 Vijak i kućište od pocinkovanog čelika

*W4 Chrom čelik

"SQ"Šelne sa gumenom oblogom W2* (a)

Gemü

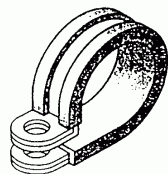

Širina 15mm

10/15	25	199 750
12/15	25	199 751
15/15	25	199 752
20/15	25	199 753
20/15	25	199 754

"SM" Šelne W1*

Gemü

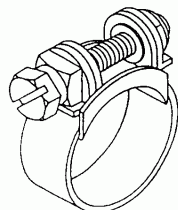

Širina 15mm

22/15	25	199 830
23/15	25	199 831
25/15	25	199 832
26/15	25	199 833

"SGB" Šelne za jako stezanje W1*

Gemü

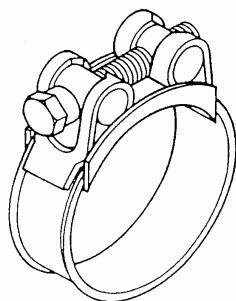

Širina 20-25mm

32-35/20		199 871
36-39/20		199 872
40-43/20		199 873
44-47/20		199 874
48-51/20		199 875
52-55/20		199 876
56-59/20		199 877
60-63/20		199 878
64-67/25		199 879
68-73/25		199 880
74-79/25		199 881
80-85/25		199 882
86-91/25		199 883
92-97/25		199 884
98-103/25		199 885
104-112/25		199 886

*W1 Vijak i kućište od pocinkovanog čelika

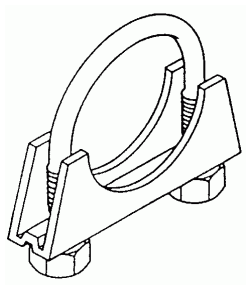
	Mera/mm	kom./pak	GRT Šifra
"UKB" Šelne za auspuh M8 (pocink)			
	26	10	199 625
	28	10	199 626
	32	10	199 627
	36	10	199 628
	38	10	199 629
	40	10	199 630
	42	10	199 631
	45	10	199 632
	48	10	199 633
	50	10	199 634
	52	10	199 635
	54	10	199 636
	58	10	199 637
	60	10	199 638
	65	10	199 639
67	10	199 640	
70	10	199 641	

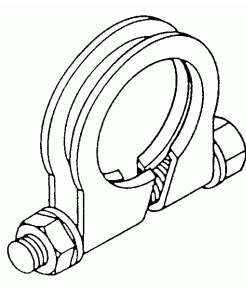
"OKB" Šelne za auspuh M8 (pocink)			
	27	10	199 675
	30	10	199 676
	33	10	199 677
	36	10	199 678
	38	10	199 679
	42	10	199 680
	45	10	199 681
	47	10	199 682
	48	10	199 683
	51	10	199 684
	55	10	199 685
	56	10	199 686
	58	10	199 687
	61	10	199 688
64	10	199 689	
70	10	199 690	

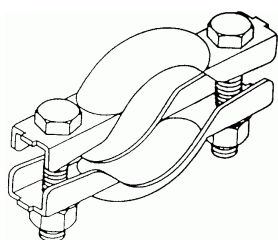
"AKB" Šelne za auspuh M8 (pocink)			
	47	10	199 725
	49	10	199 726
	53	10	199 727
	58	10	199 728
	66	10	199 729
	69	10	199 730

Set šelni W2B*

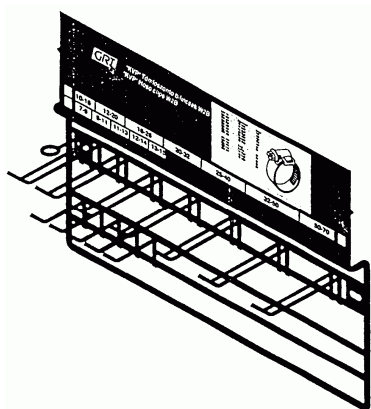

Stalak za šelne 200 349

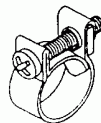
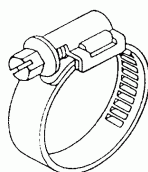

Sastav-kom/set
GRT Šifra / set

Mera/mm	kom	GRT Šifra
10-16/9	10	200 400
12-22/9	10	200 401
16-28/9	10	200 402
20-32/9	10	200 403
25-40/9	10	200 404
32-50/9	10	200 405
50-70/9	10	200 406
8/9	10	199 800
10/9	10	199 802
12/9	10	199 804
13/9	10	199 805
14/9	10	199 806

GRT

120
200 410

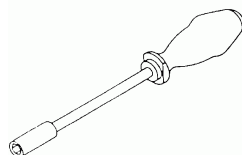

Šestougaoni Odvijač za šelne 7mm

*W2B traka od chromiranog čelika, vijak i kućište od pocinkovanog lima

Mera/mm	kom./pak	GRT Šifra
---------	----------	-----------

Creva za goriva (obložena textilom)

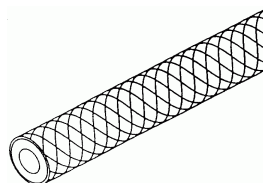

3,2*8	25	200 600
4*8	25	200 601
5*10	25	200 602
6*11	15	200 603
8*14	15	200 604
10*16	10	200 605
12*18	5	200 606

Plastična providna creva (PVC)

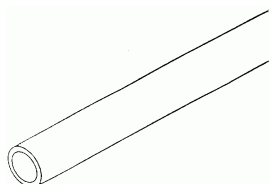

4*6	25	200 610
5*7	25	200 611
6*9	25	200 612
8*11	20	200 613
10*14	10	200 614

Plastična providna creva pojačana (PVC)

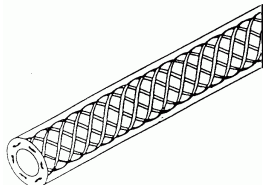

5*8	25	200 620
6*10	25	200 621
8*13	20	200 622
10*15	10	200 623
13*17	10	200 624

Cevi za izolaciju (crna)

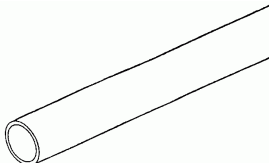

5	100	105 142
8	100	105 143
10	50	105 145
14	50	105 144
20	25	105 146

Set creva za gorivo (obloženi tekstilom)

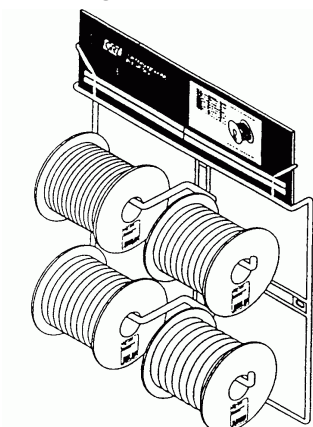

Sastav-m/set
GRT Šifra / set

GRT Š
65
200 650

Nosač za creva 200 352

3,2*8	25m	200 600
6*11	15m	200 603
8*14	15m	200 604
10*16	10m	200 605

"Mini" filter za gorivo

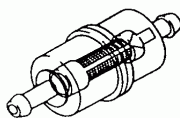

Univerzalni mini predfilter za benzin

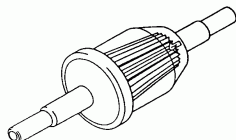

Univerzalni mini predfilter za naftu

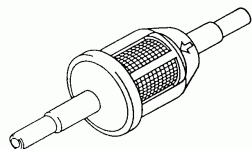

Univerzalni predfilter za benzin

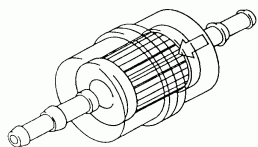

Univerzalni predfilter za naftu

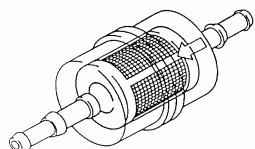

Univerzalni "maxi" predfilter za naftu

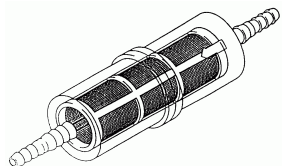

R/mm	Mera/mm	kom/pak	GRT Š
5	19*59	10	200 700

6-8	35*109	20	200 701
-----	--------	----	---------

6-8	36*108	20	200 702
-----	--------	----	---------

6-8	50*123	5	200 703
-----	--------	---	---------

6-8	50*123	5	200 704
-----	--------	---	---------

8-10	46*206	5	200 705
------	--------	---	---------